

1

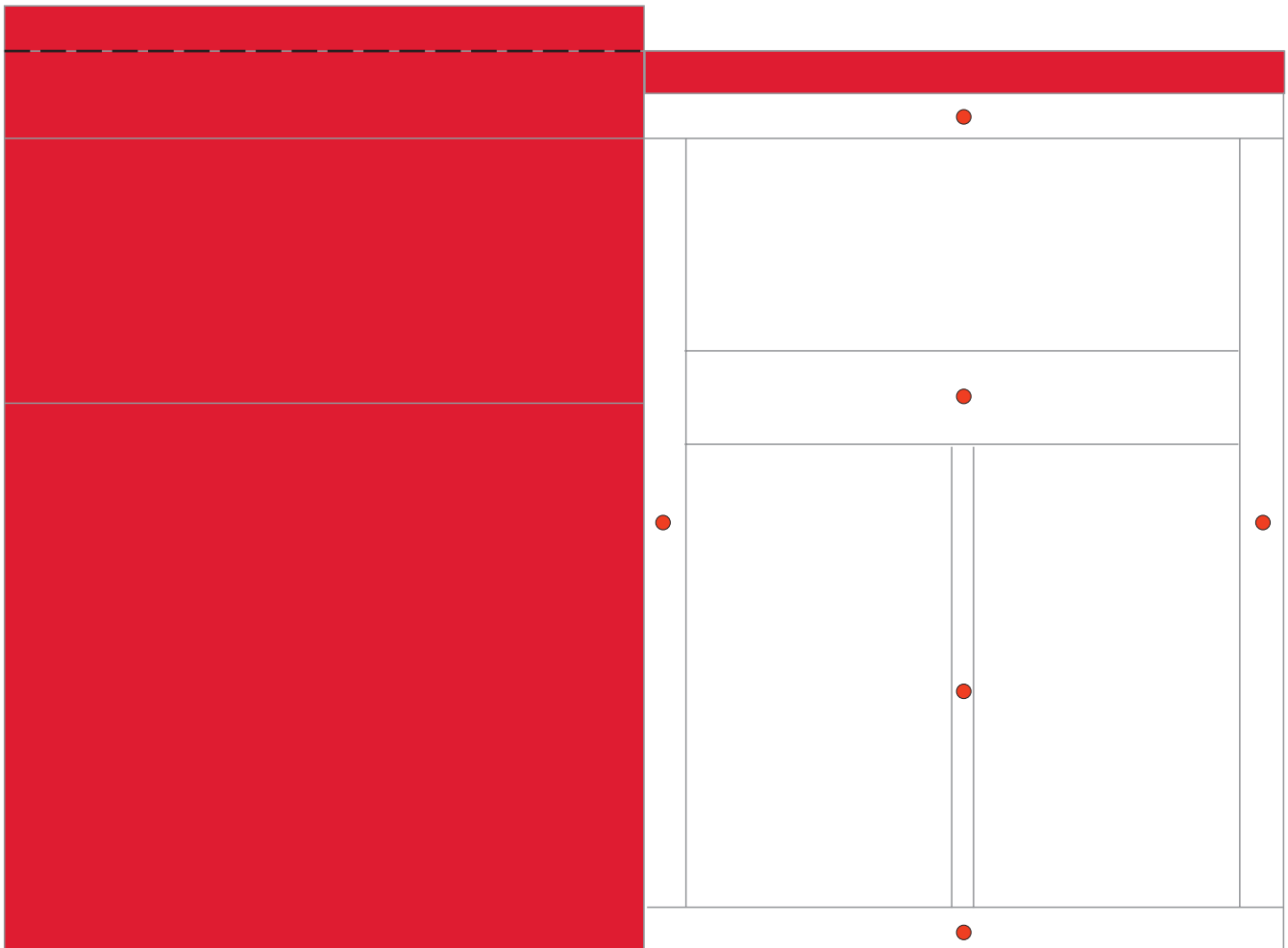

2

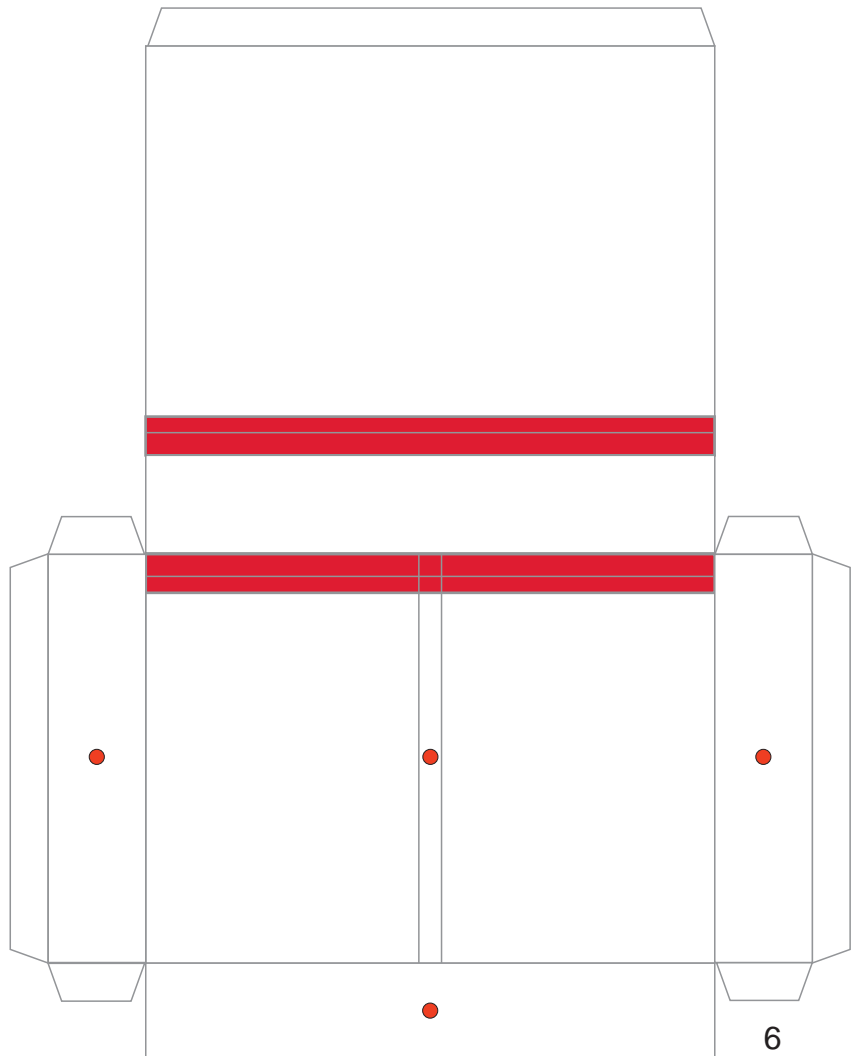

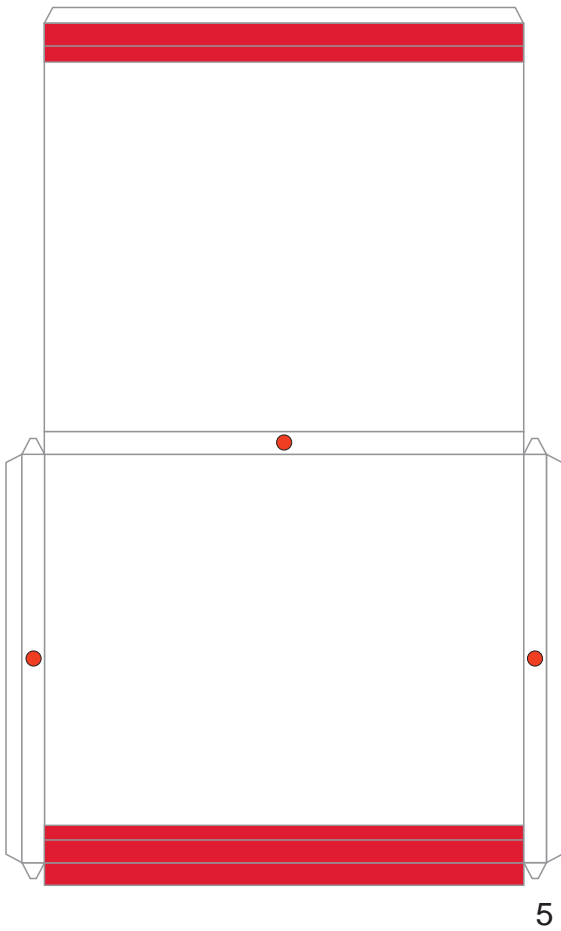
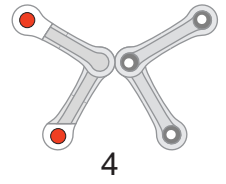
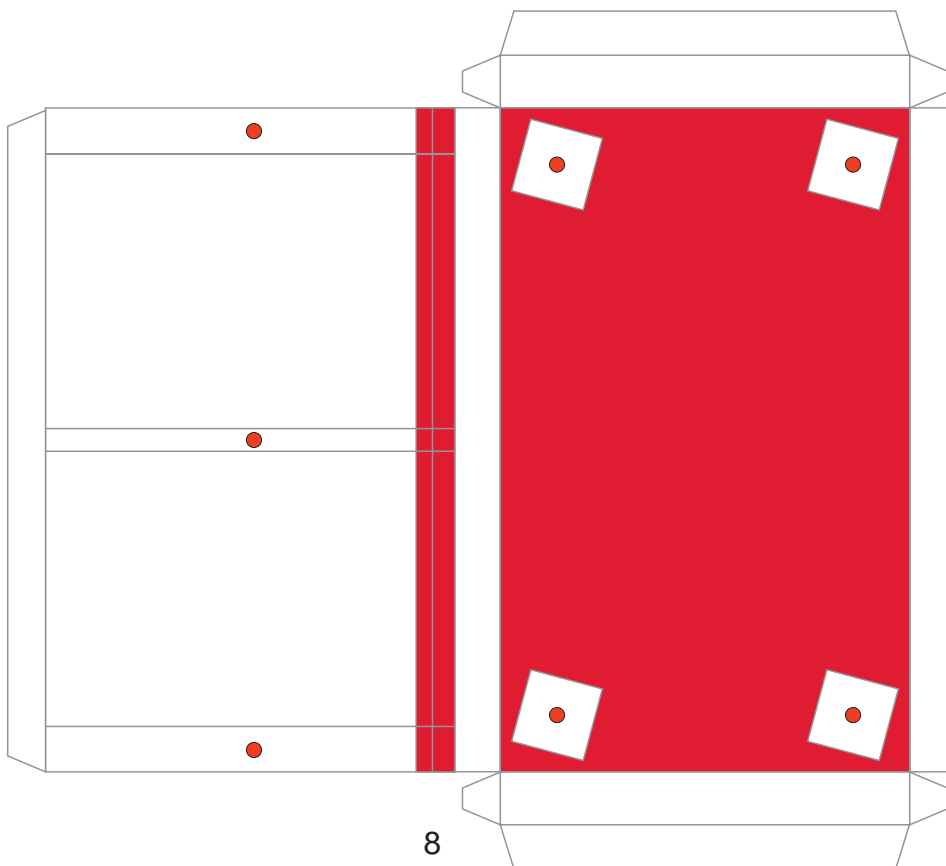
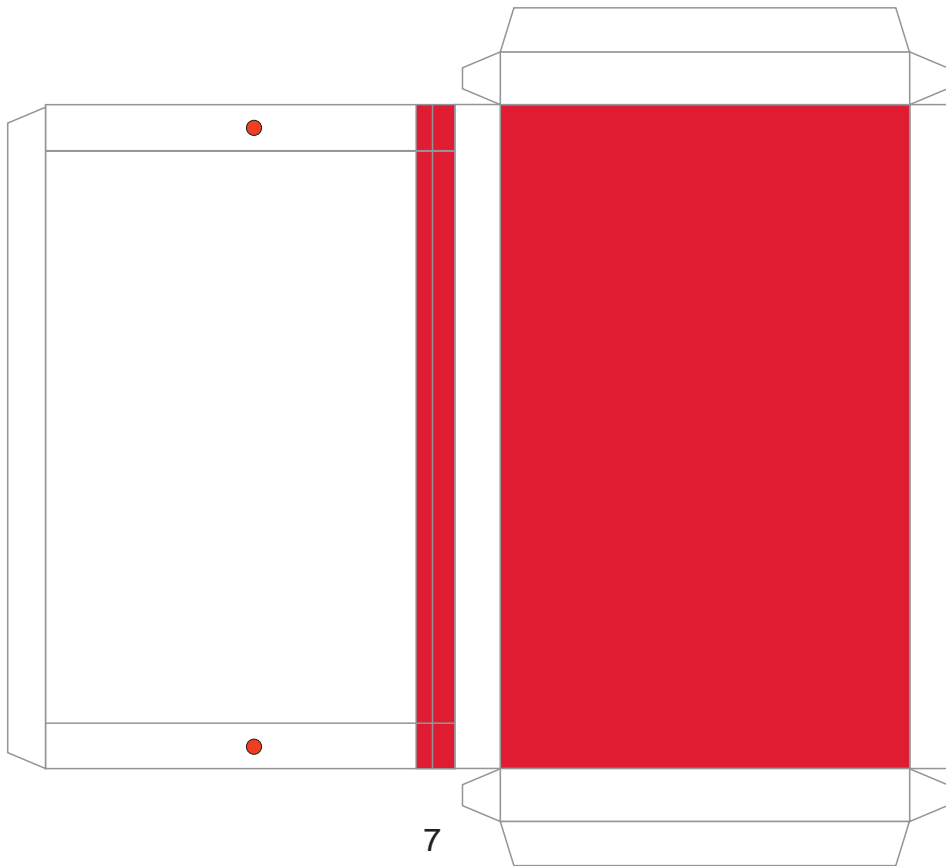

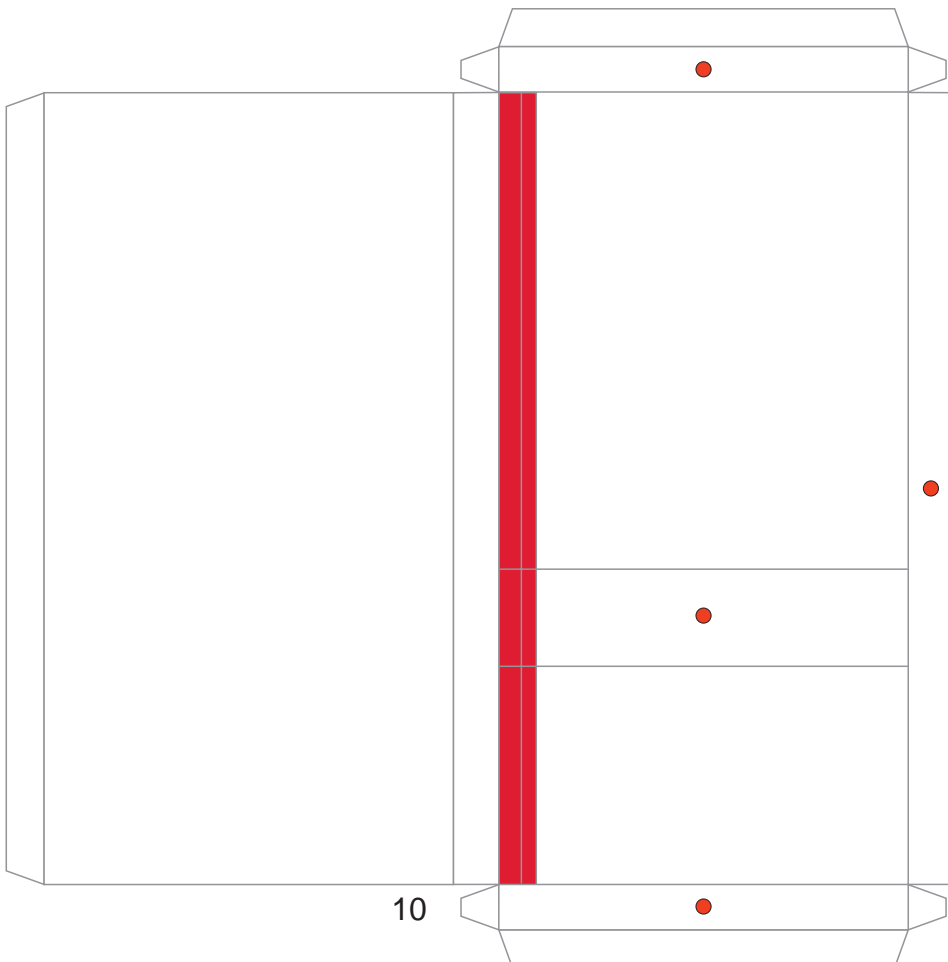
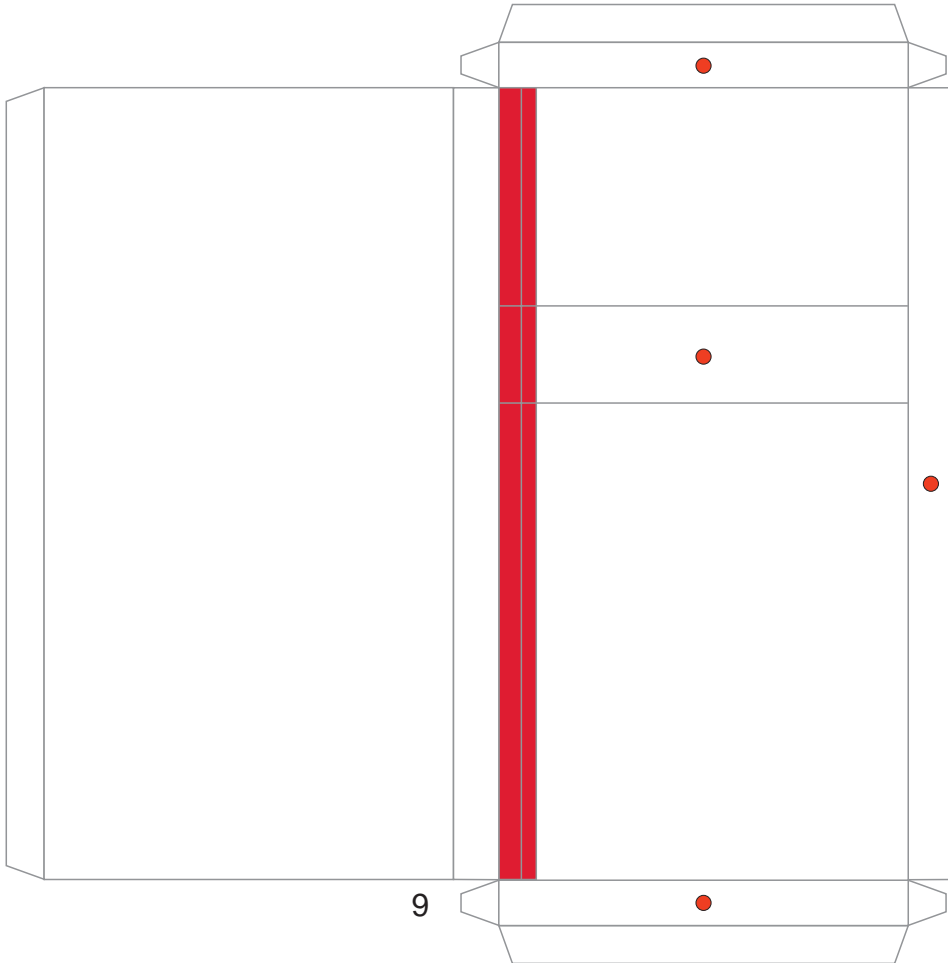

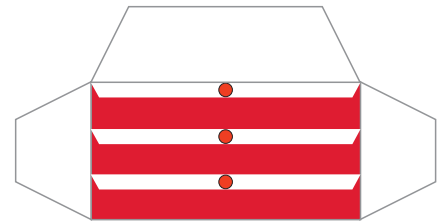
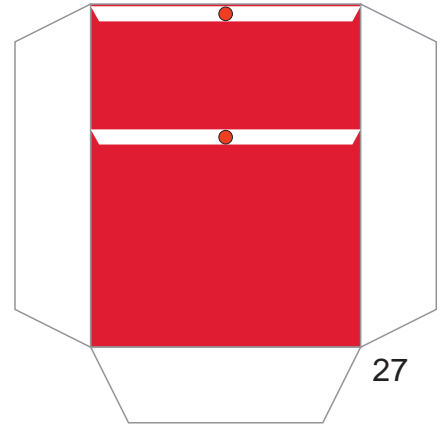
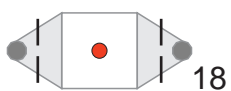
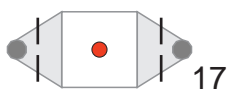
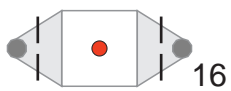
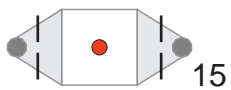
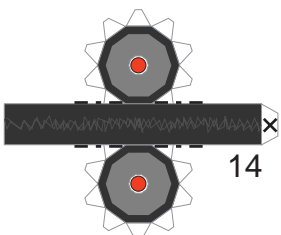
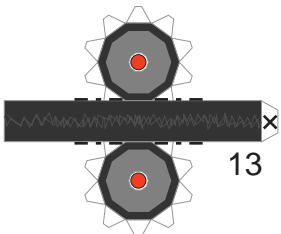
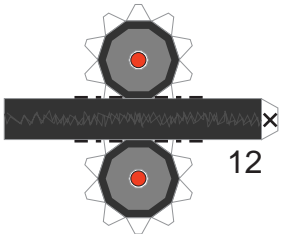
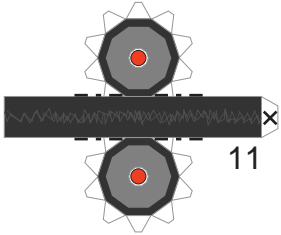

26

27

28

29

30

31

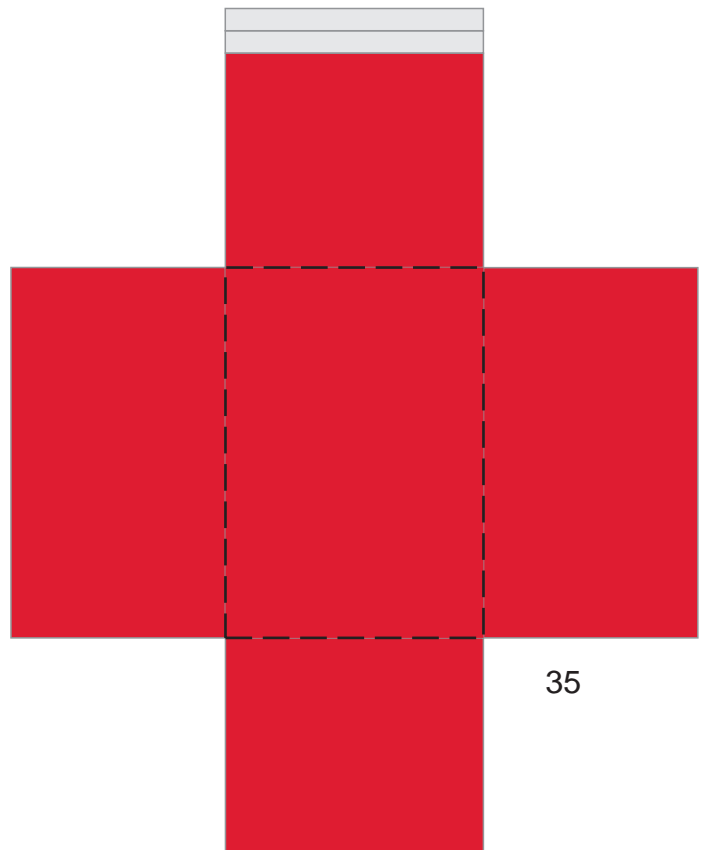
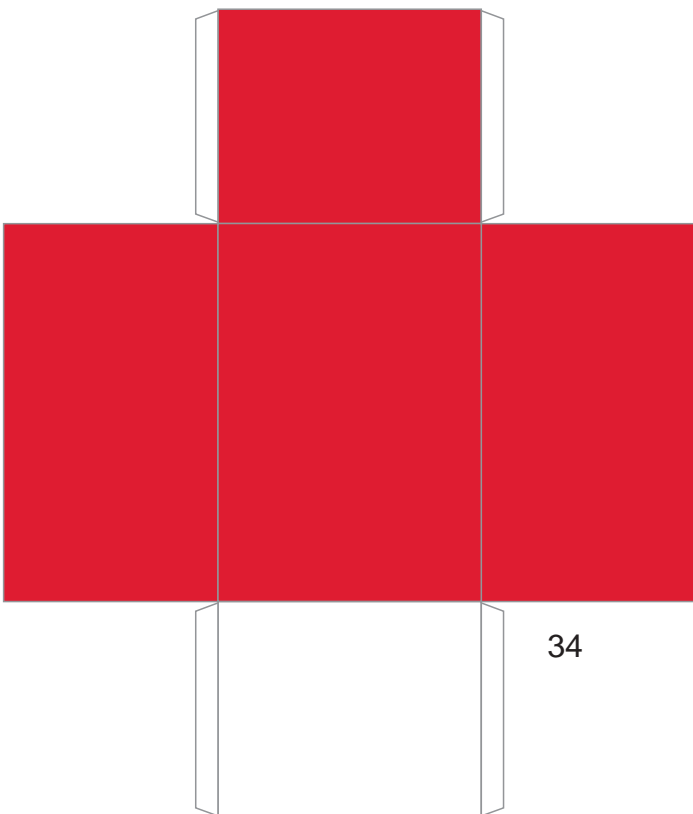
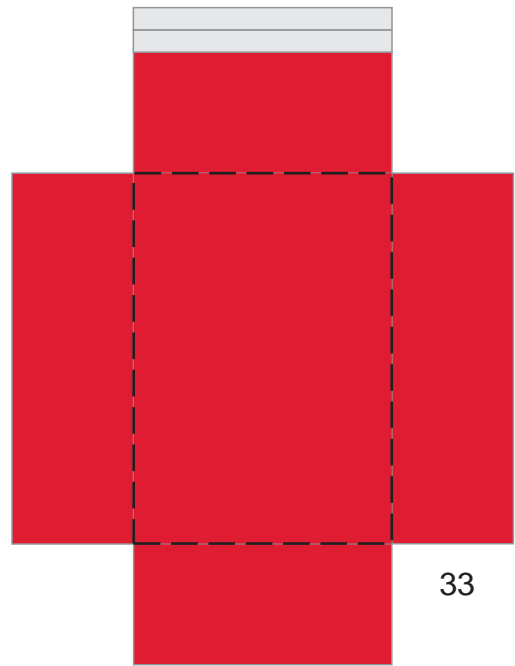
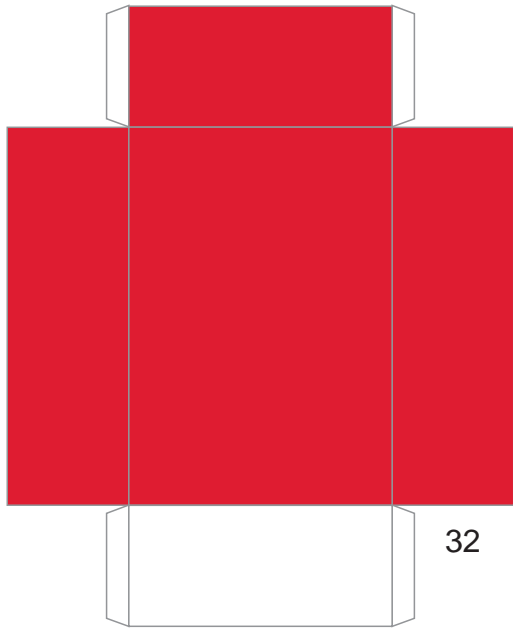

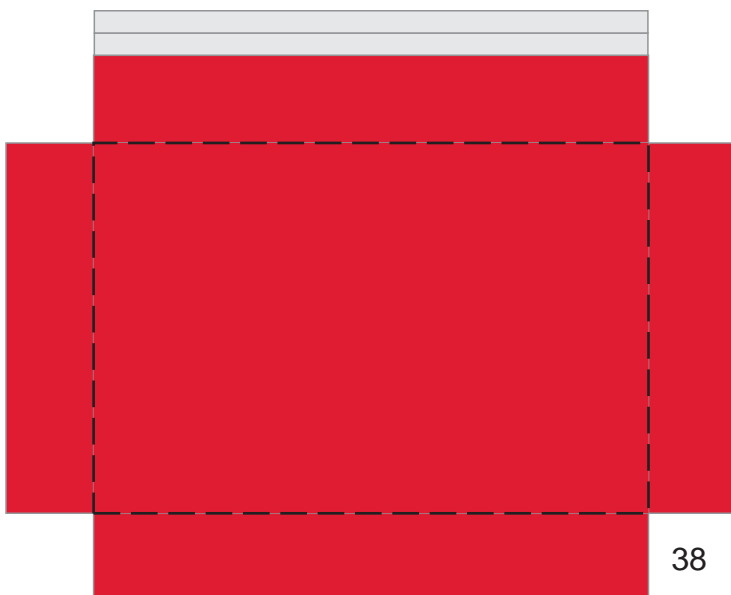
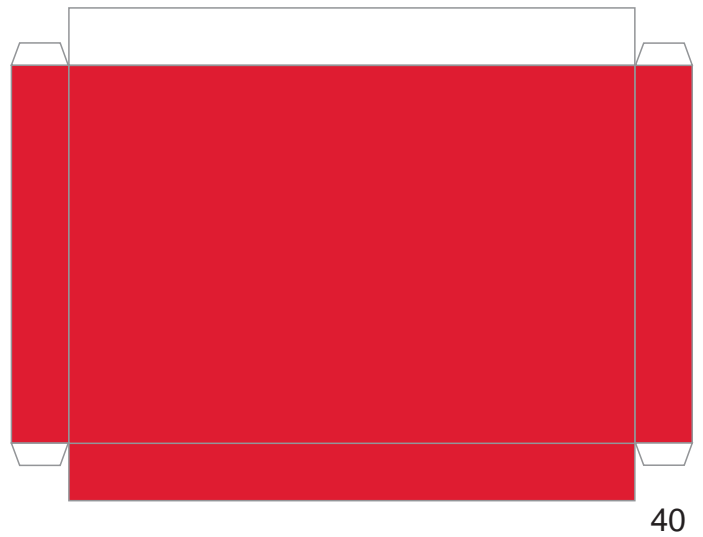
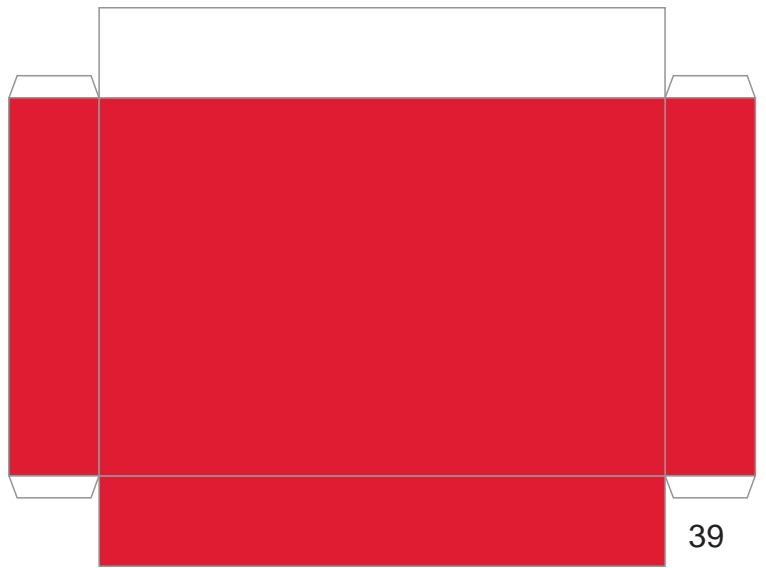

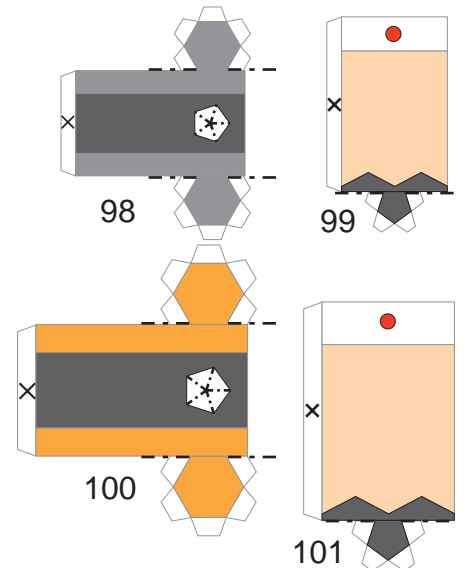
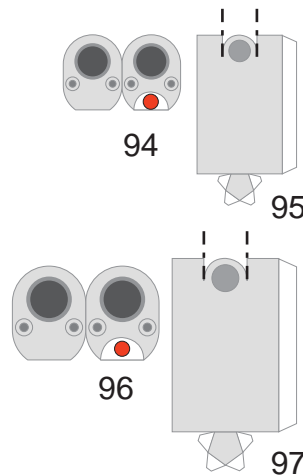
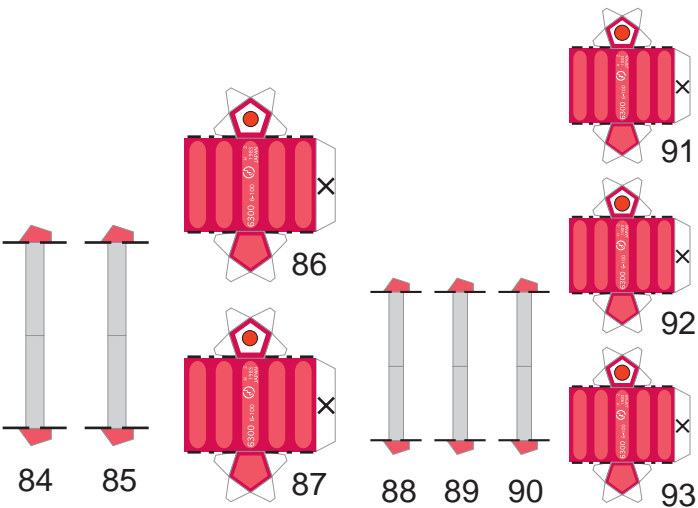
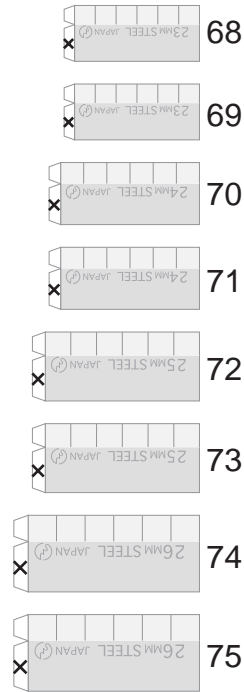
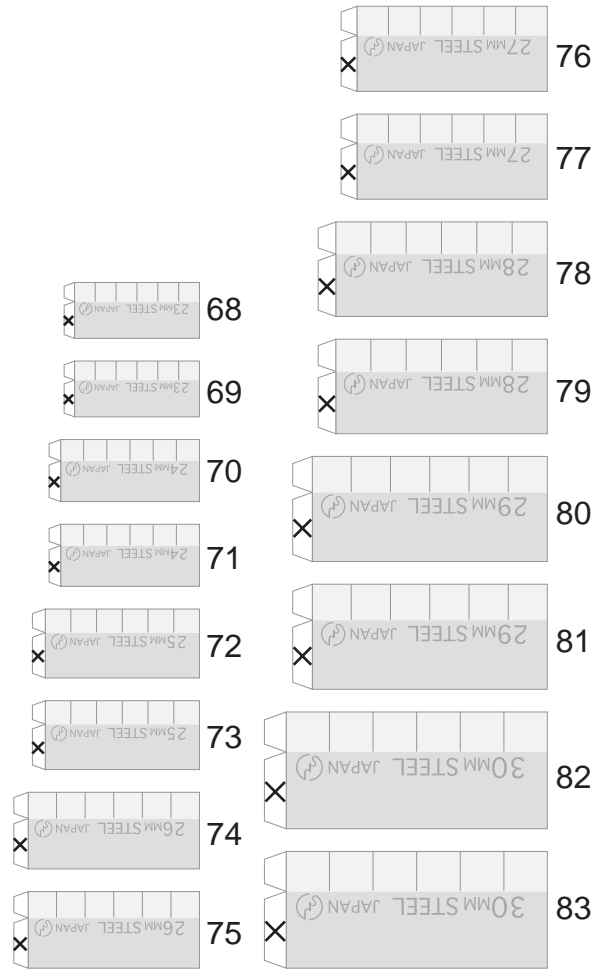
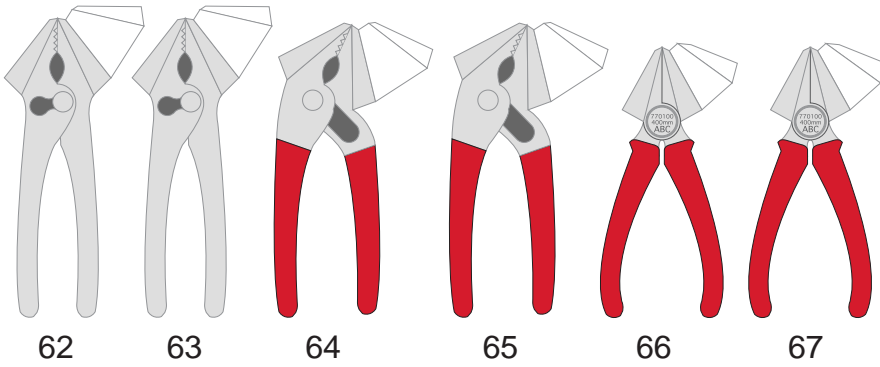
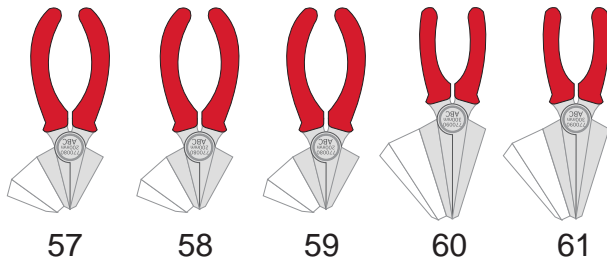
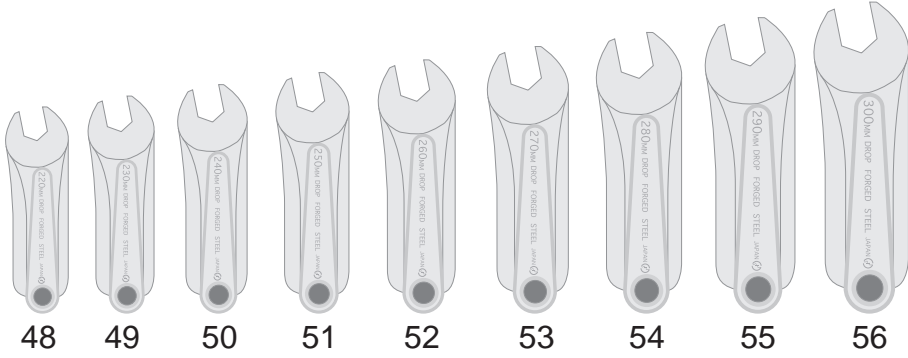
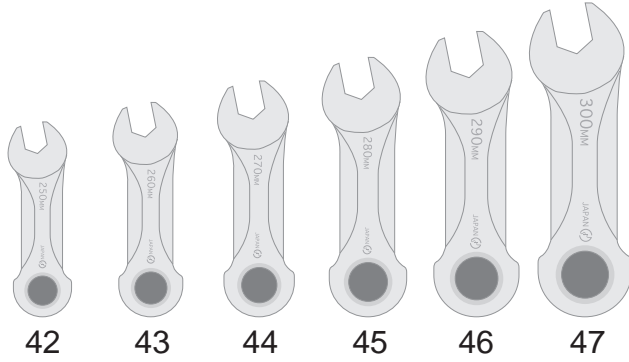



1

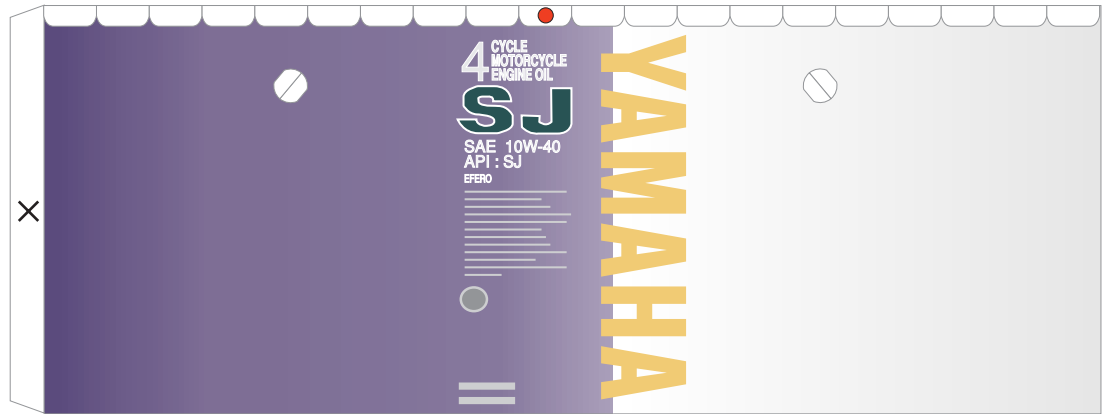

2

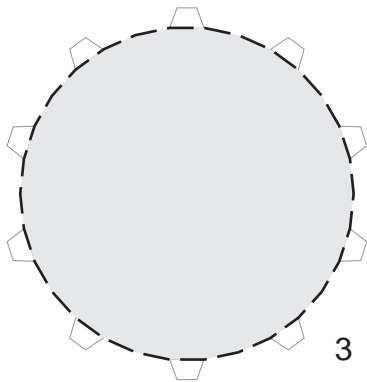

3

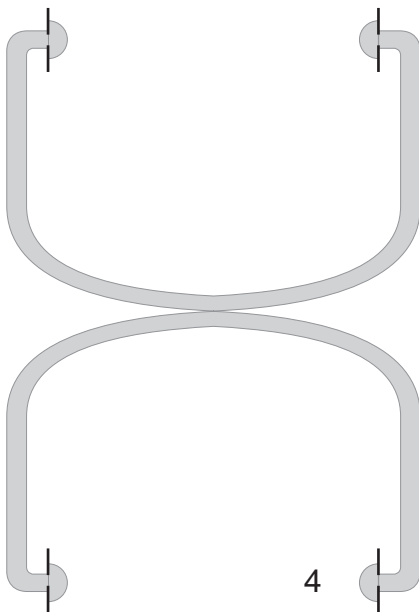
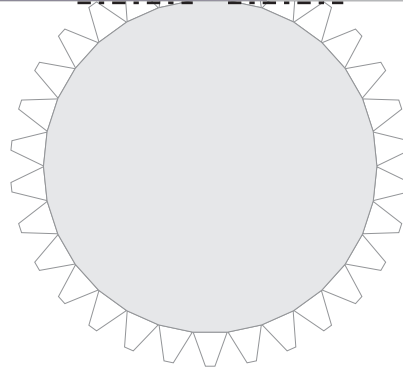

4

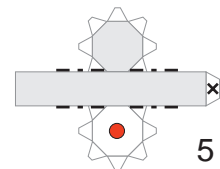

5



6

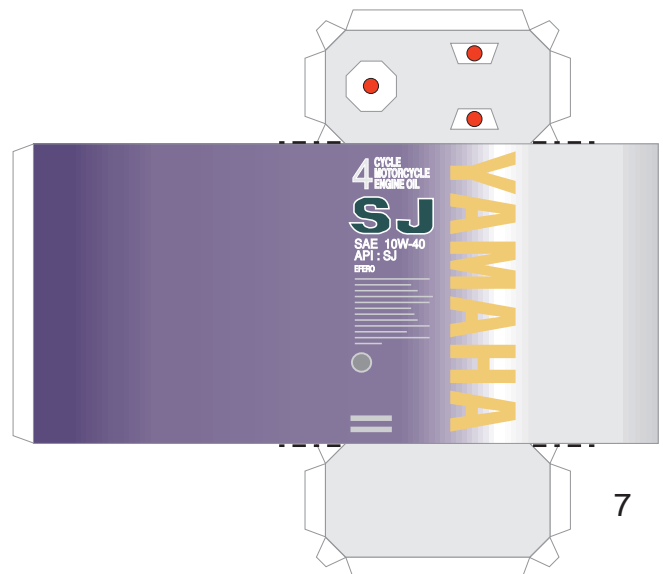

7

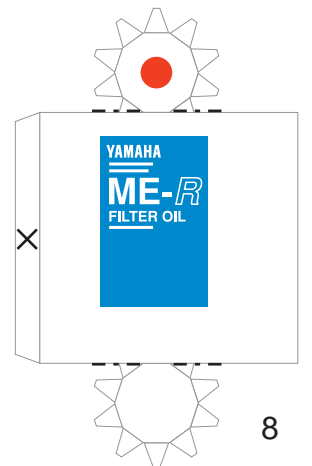
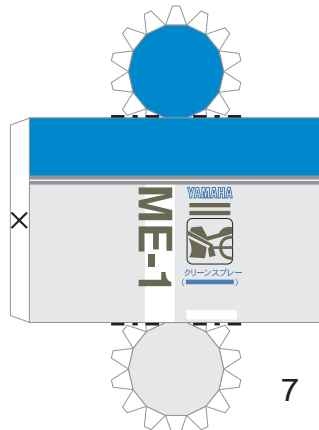
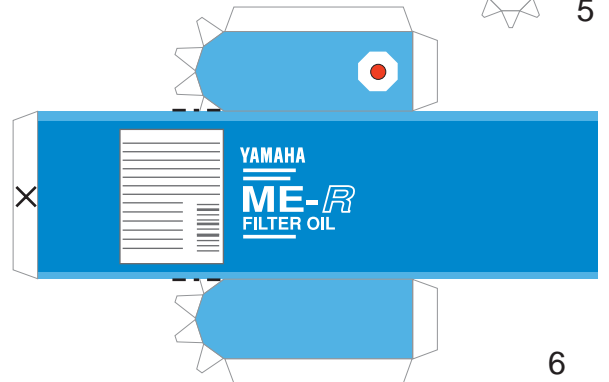
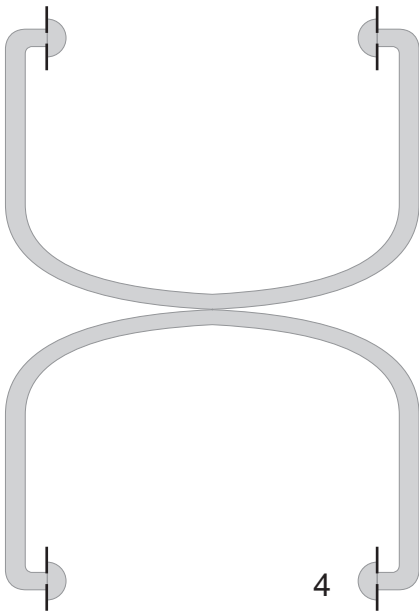
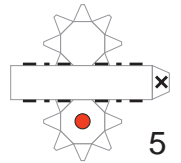
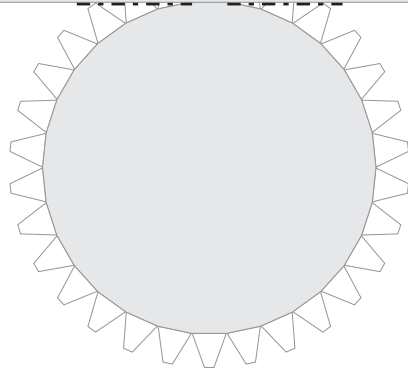
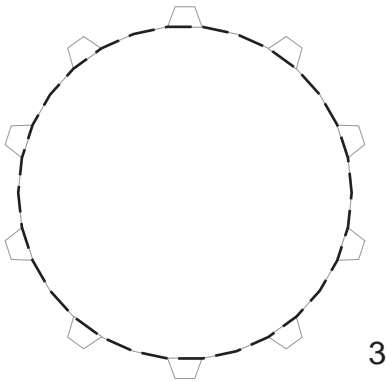
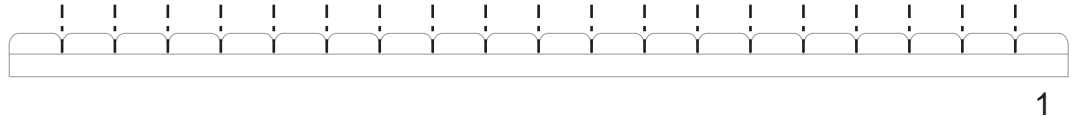

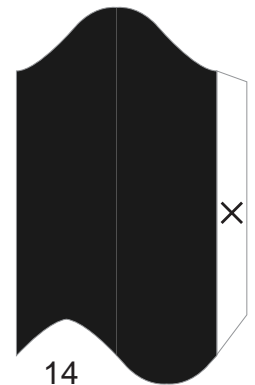
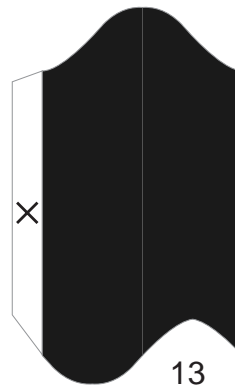
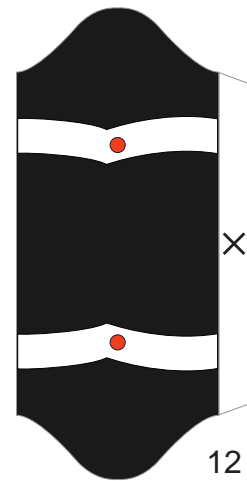
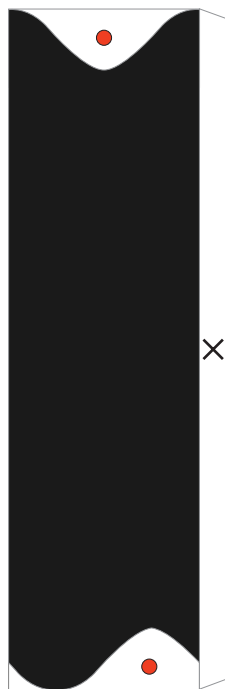
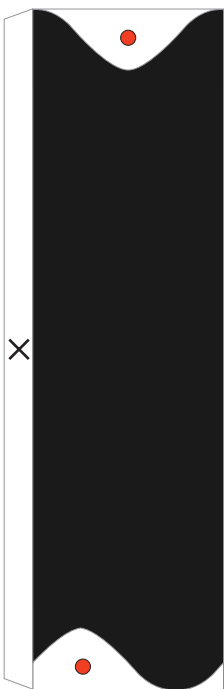
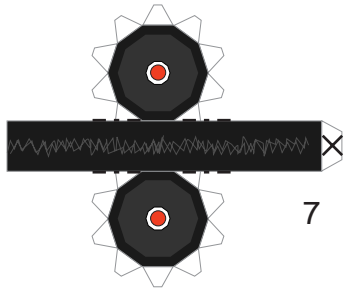
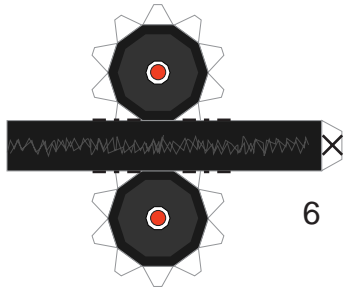
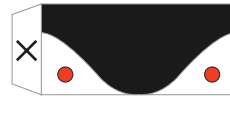
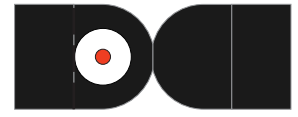
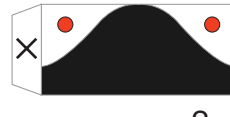
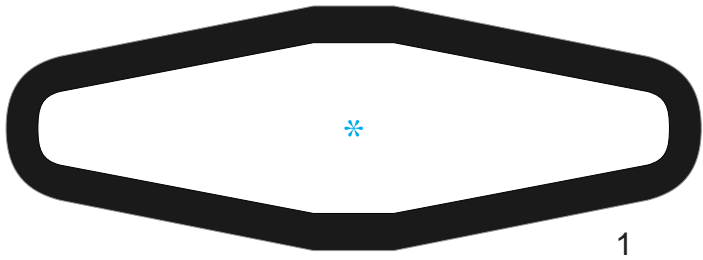

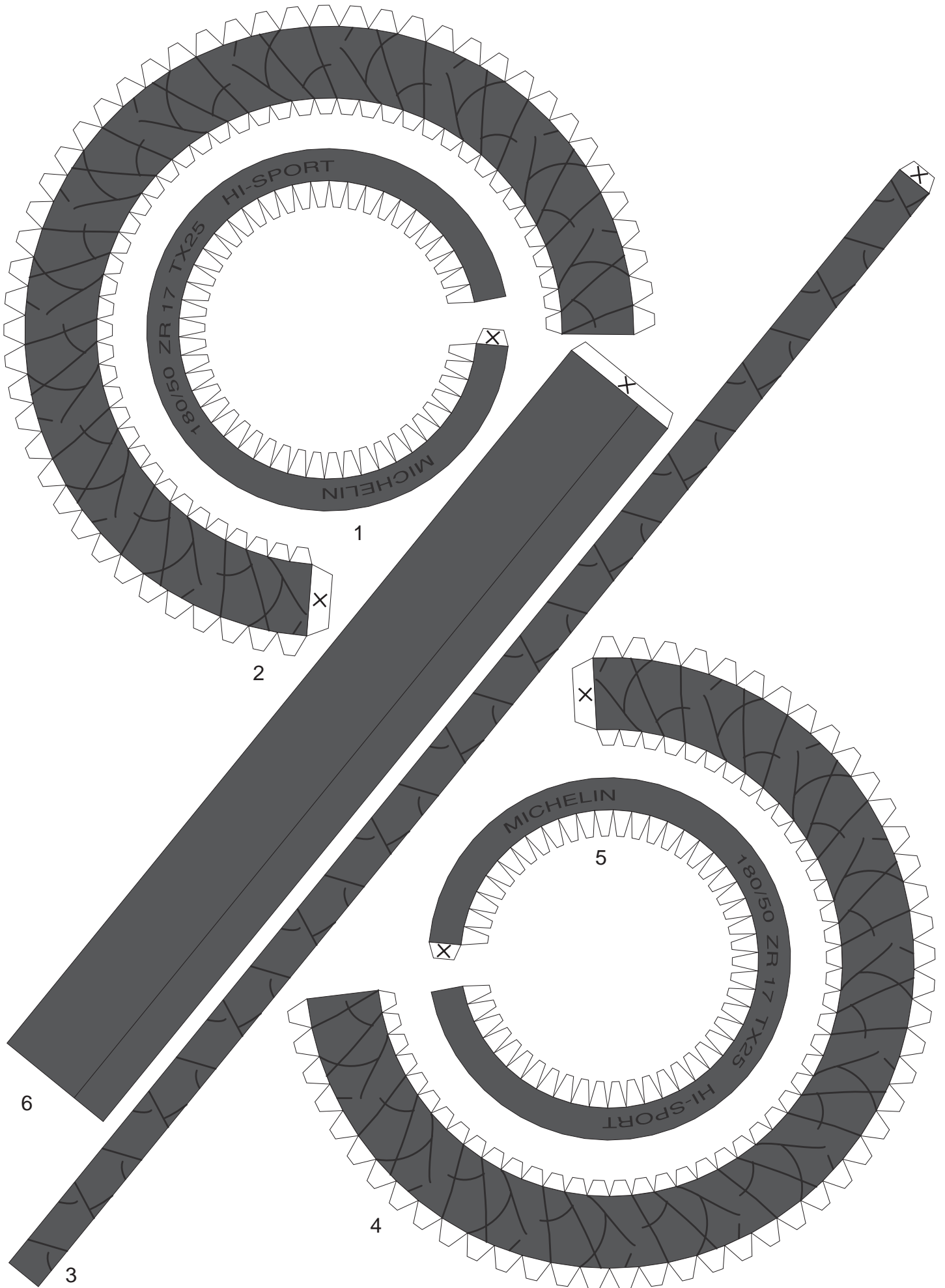



- This pattern is designed to look like a concrete wall.  
Use as a garage floor or wall.  
When printing or photocopying, enlarge the pattern to desired size.
- \* Pasting the paper walls to cardboard is recommended for reinforcement.